

IMA

cenová hladina 7



IMA

materiál: MDF polievaná + ABS hrana / LDTD + ABS hrana

hrúbka: 18 mm

zadná strana: v dekore prednej plochy

poznámka: úchytka je súčasťou prednej plochy, prevedenie nerez



7 cenová hladina

biela polievaná
supermat
/BIPS/

kašmír polievaná
supermat
/KAPS/

oxid červený
/OXCE/

zelená lesná
/ZELE/

chromix strieborný
/ACST/

ferro bronzový
/AFBR/

dub halifax biely
/DHAB/

jaseň horský
/JASH/



IMA 2

cenová hladina 7



IMA 2

materiál: MDF polievaná + ABS hrana / LDTD + ABS hrana

hrúbka: 18 mm

zadná strana: v dekore prednej plochy

poznámka: úchytky je súčasťou prednej plochy, prevedenie titán

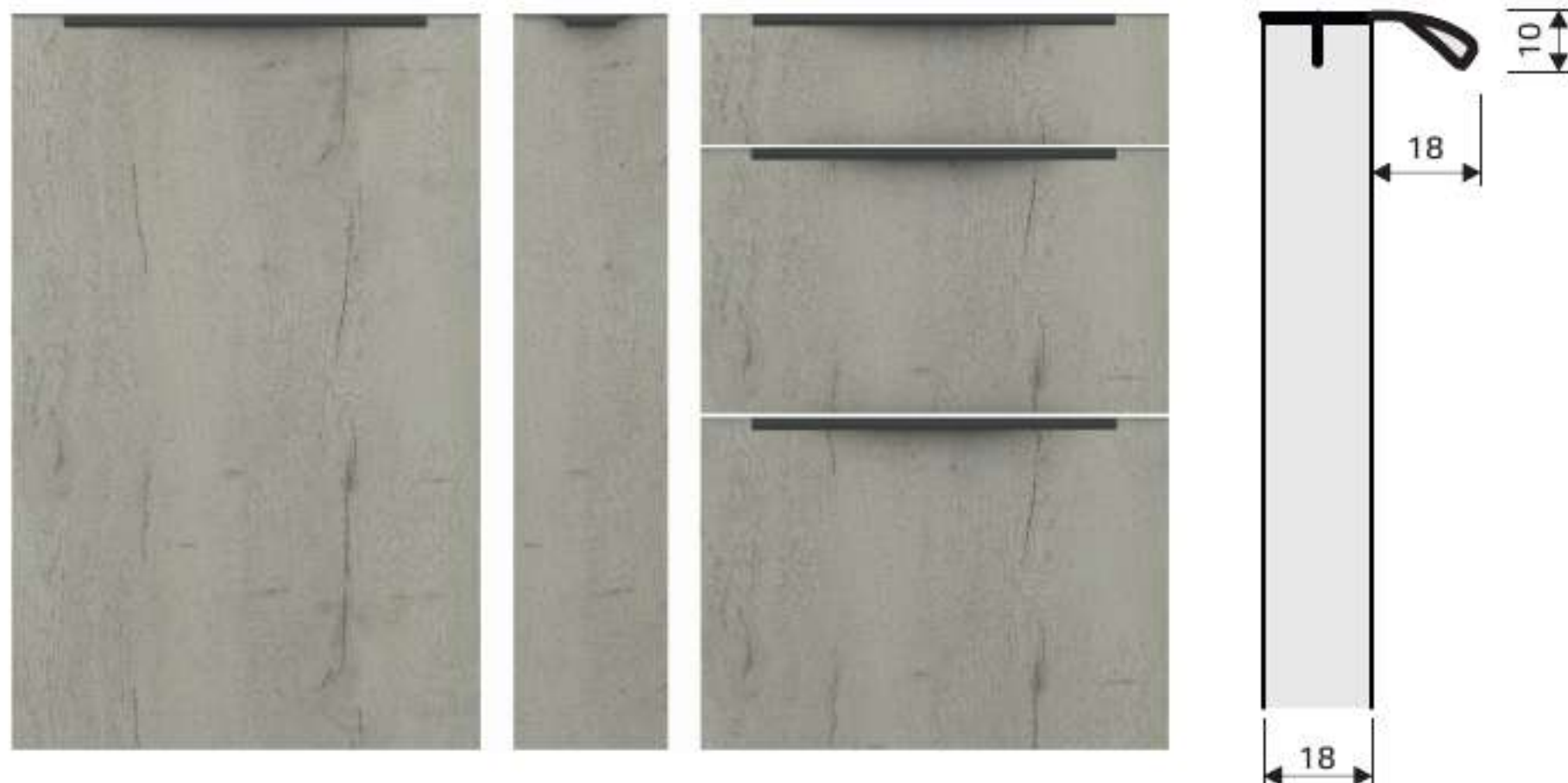

7 cenová hladina

biela polievaná
supermat
/BIPS/

kašmír polievaná
supermat
/KAPS/

oxid červený
/OXCE/

zelená lesná
/ZELE/

chromix strieborný
/ACST/

ferro bronzový
/AFBR/

dub halifax biely
/DHAB/

jaseň horský
/JASH/



REA

cenová hladina 4



REA

materiál: LDTD + ABS hrana

hrúbka: 18 mm

zadná strana: v dekore prednej plochy

**4** cenová hladinaoxid červený
/OXCE/zelená lesná
/ZELE/chromix strieborný
/ACST/ferro bronzový
/AFBR/dub halifax biely
/DHAB/jaseň horský
/JASH/

RUT

cenová hladina

6



RUT

materiál: MDF + fólia

hrúbka: 19/16 mm

zadná strana: vanilka

poznámka: skladané od šírky 230 mm, bočné vlysy naložené, výplň s horizontálnou textúrou

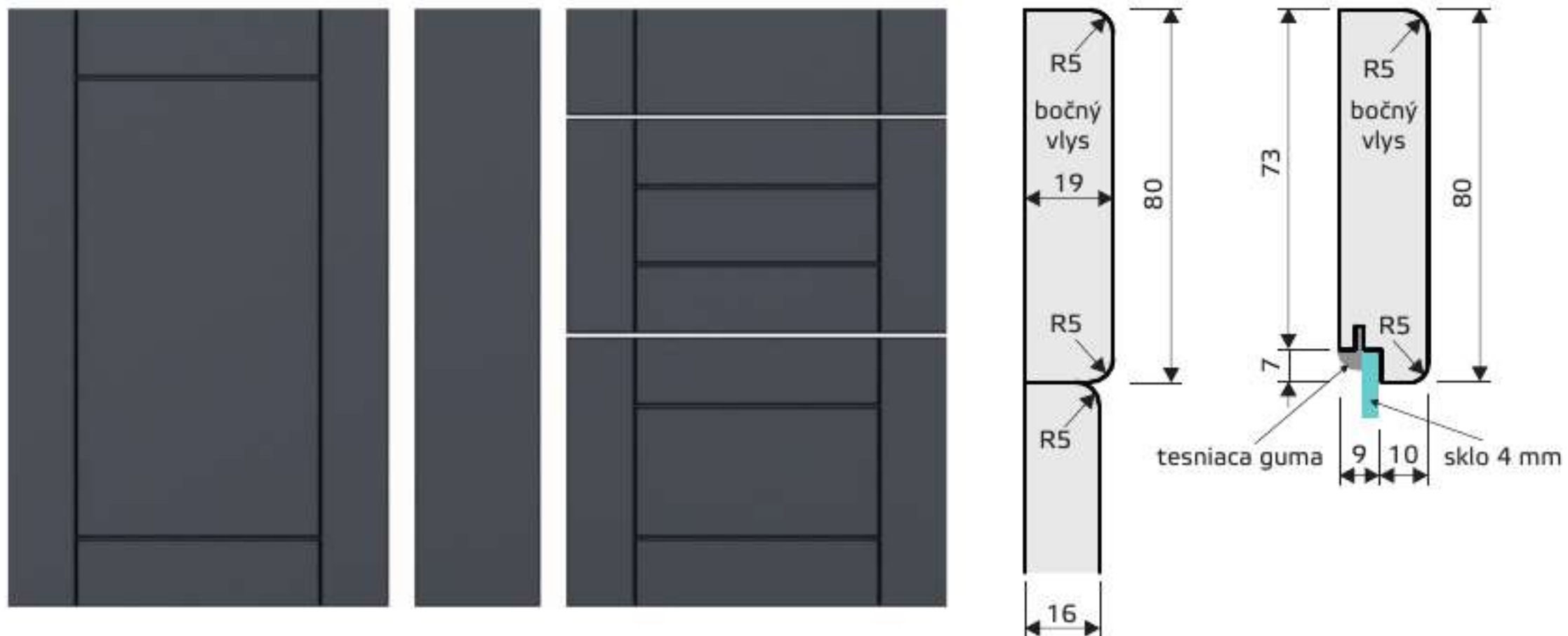
**6** cenová hladinamagnólia
/MAGN/fjord
/FJOR/cement
/CEME/šedý kameň raster
/SKAR/

ASTÓRIA

cenová hladina 4



ASTÓRIA

materiál: MDF + fólia

hrúbka: 16 mm

zadná strana: vanilka

poznámka: frézovanie do plochy od šírky 269 mm a výšky 125 mm

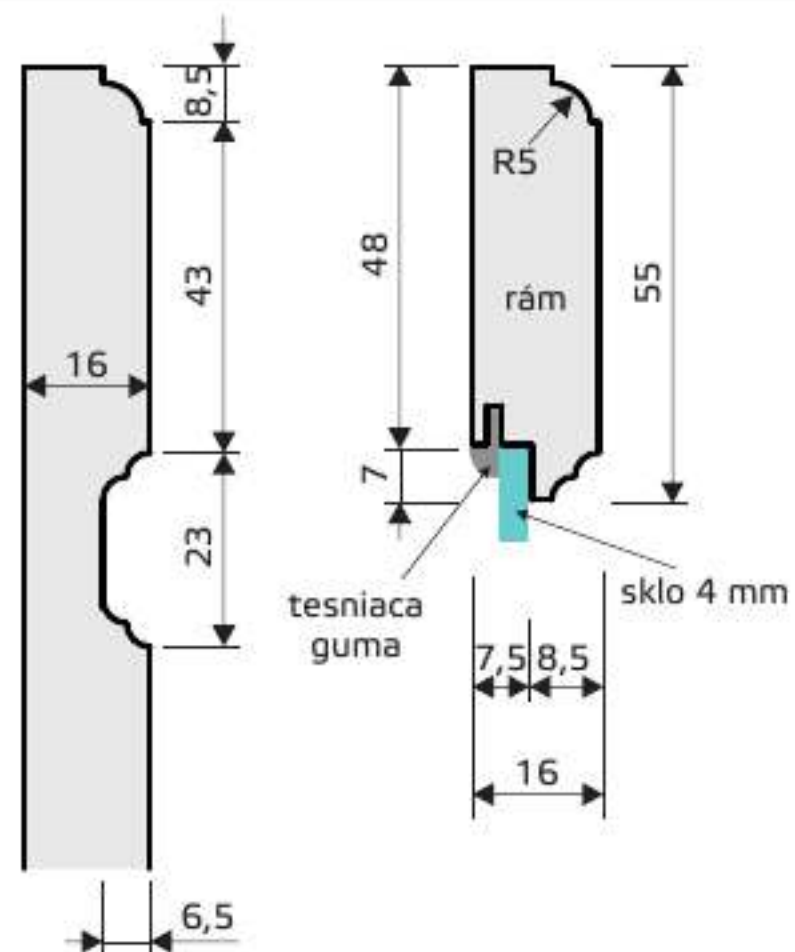
**4** cenová hladinabiela arctic
/BIAA/muša
/MUSE/pino aurelio
/PINO/vanilka patina
/VPAT/dub bardolino
/DBAR/dub riviera mountain
/DMON/sklo flint
/Z3/sklo čire
/Z5/

BIBIANA

cenová hladina 4



BIBIANA

materiál: MDF + fólia

hrúbka: 16 mm

zadná strana: vanilka

poznámka: frézovanie do plochy od šírky 269 mm a výšky 125 mm

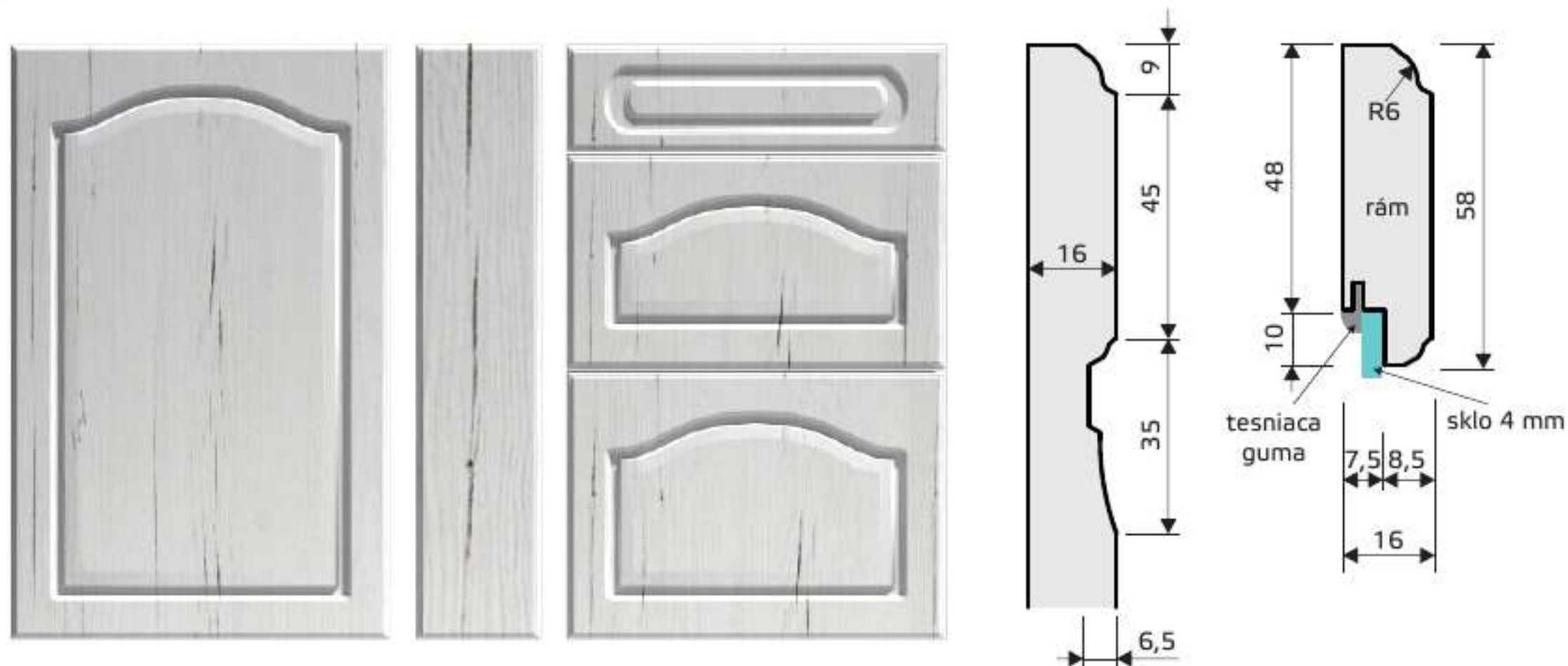
**4** cenová hladinavanilka patina
/VPAT/pino aurelio
/PINO/kašmír raster
/KASR/dub riviera mountain
/DMON/dub halifax tabak
/DHAT/sklo flint
/Z3/sklo čire
/Z5/

CARMEN

cenová hladina 4



CARMEN

materiál: MDF + fólia
 hrúbka: 16 mm
 zadná strana: vanilka

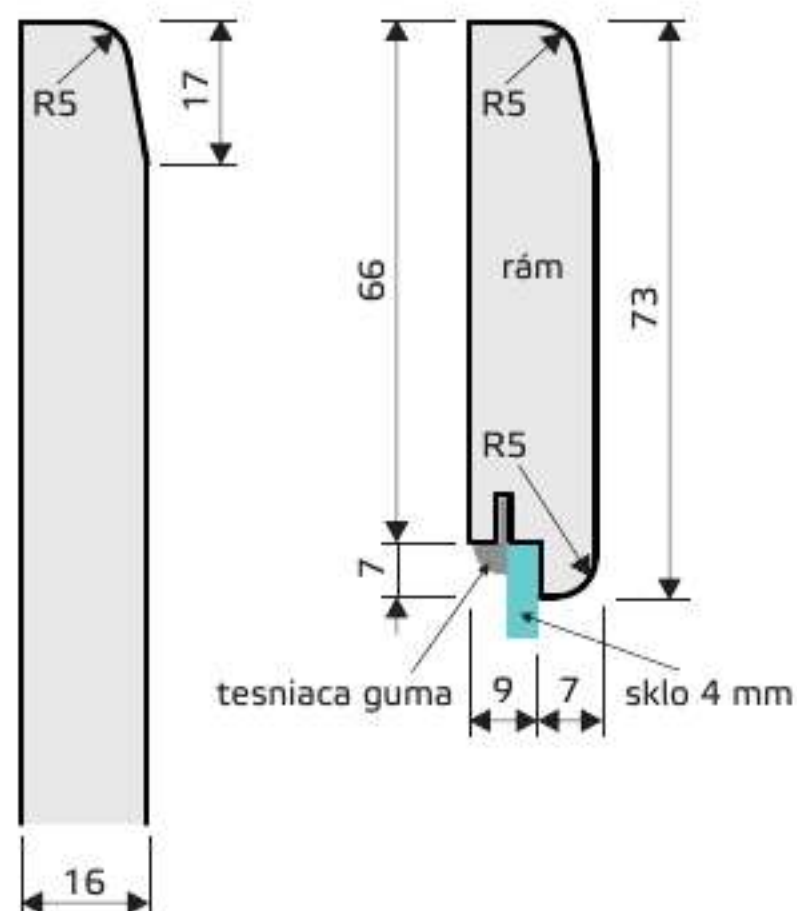
**4** cenová hladina

biela arctic
/BIAA/



vanilka
/VANI/



kašmír
/KASM/



pino aurelio
/PINO/



magnólia
/MAGN/



dub san remo sand
/DSAN/



sklo satinované
/Z1/



sklo čire
/Z5/



CORA

cenová hladina 2-4



CORA

materiál: LDTD + ABS hrana

hrúbka: 18 mm

zadná strana: v dekore prednej plochy

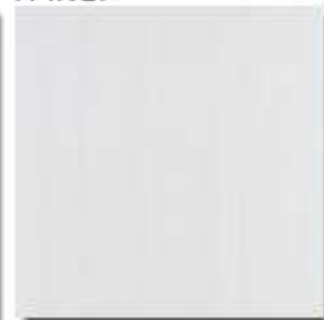
**2** cenová hladinapiesok
/PIES/kašmír
/KASM/šedý kameň
/SEKA/pino aurelio
/PINO/dub arlington
/DARL/dub bardolino
/DBAR/dub nelson
/DNLS/**4** cenová hladinabiela vysoký lesk
/BIEL/ivory vysoký lesk
/IVOL/šedá vysoký lesk
/SEDL/šedá diamant
/SEDD/sklo satinované
/Z1/sklo čire
/Z5/

DONA

cenová hladina 4



DONA

materiál: LDTD + ABS hrana

hrúbka: 18/8 mm

zadná strana: v dekore prednej plochy

poznámka: bočné vlysy naložené

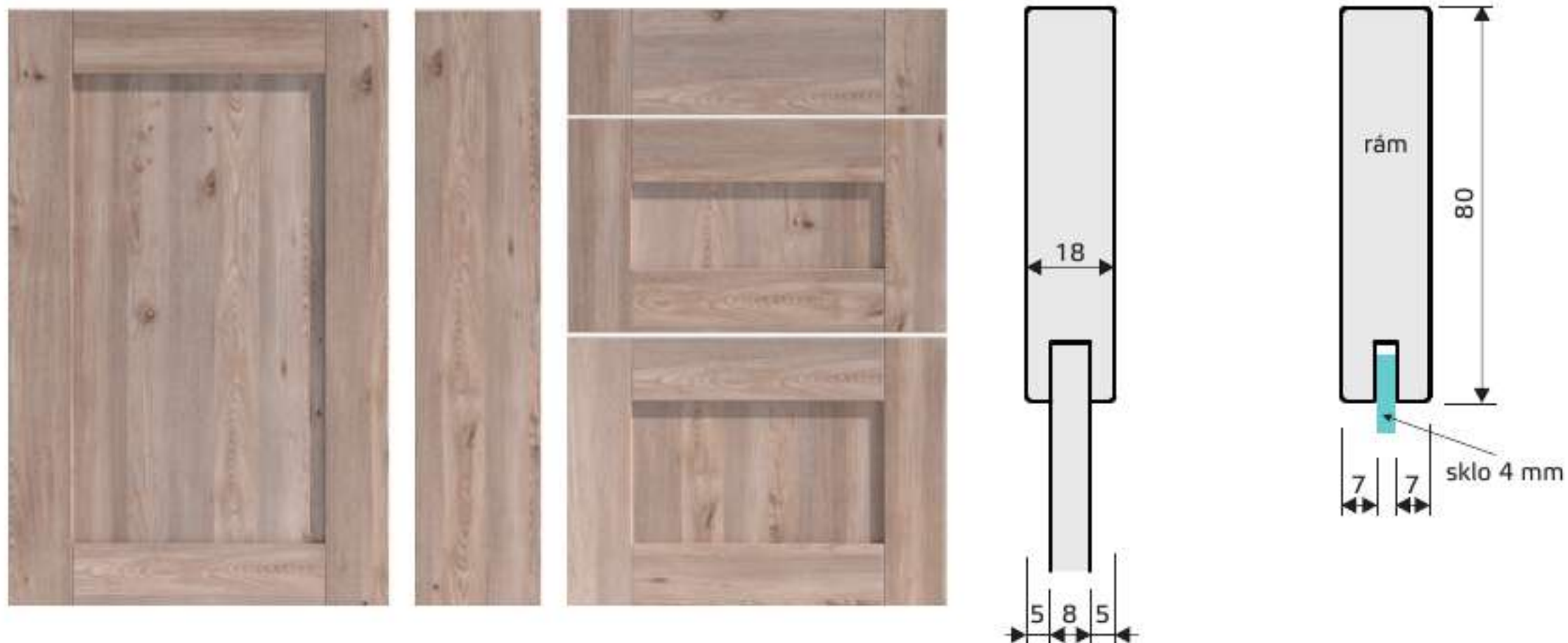
**4** cenová hladinapiesková
/PIES/šedá
/SEDA/pino aurelio
/PINO/dub san remo sand
/DSAN/dub nelson
/DNLS/sklo satinované
/Z1/sklo čire
/Z5/

ELIS

cenová hladina 5



ELIS

materiál: MDF + fólia
 hrúbka: 16 mm
 zadná strana: vanilka

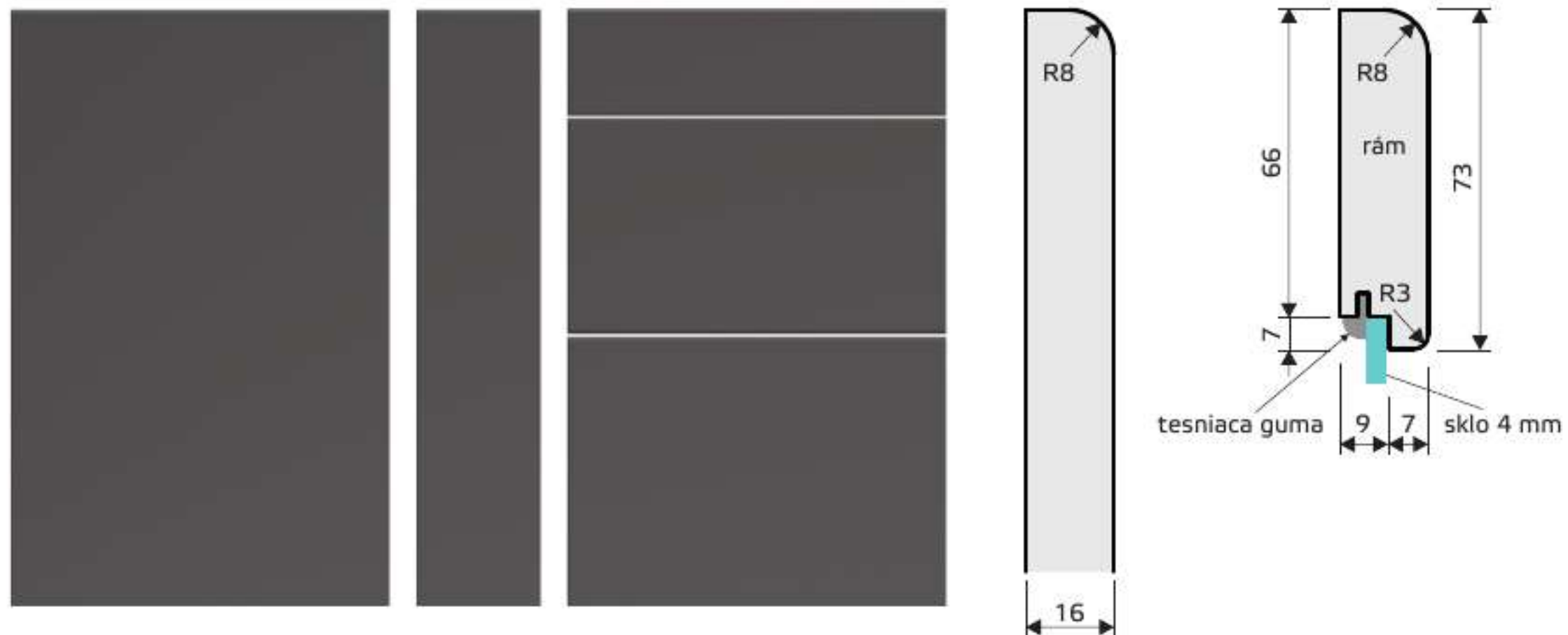
**5** cenová hladina

biela arctic
 vysoký lesk
 /BIAL/



vanilka
 vysoký lesk
 /AVL/



grafit
 vysoký lesk
 /GRAL/



biela arctic
 /BIAA/



dub bardolino
 /DBAR/



sklo satinované
 /Z1/



sklo čire
 /Z5/



ESTER

cenová hladina 6

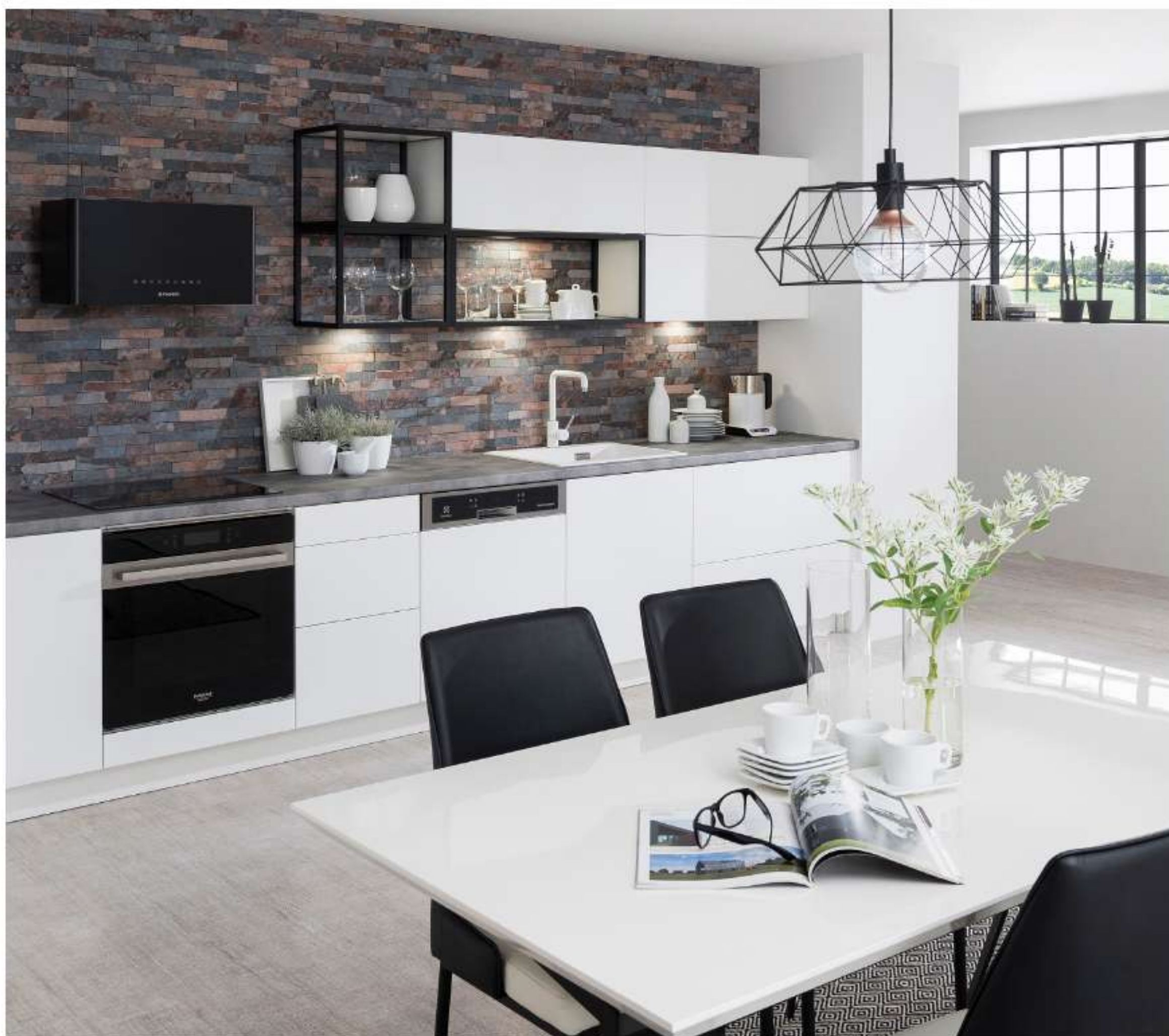

ESTER

materiál: MDF + fólia
 hrúbka: 19 mm
 zadná strana: vanilka

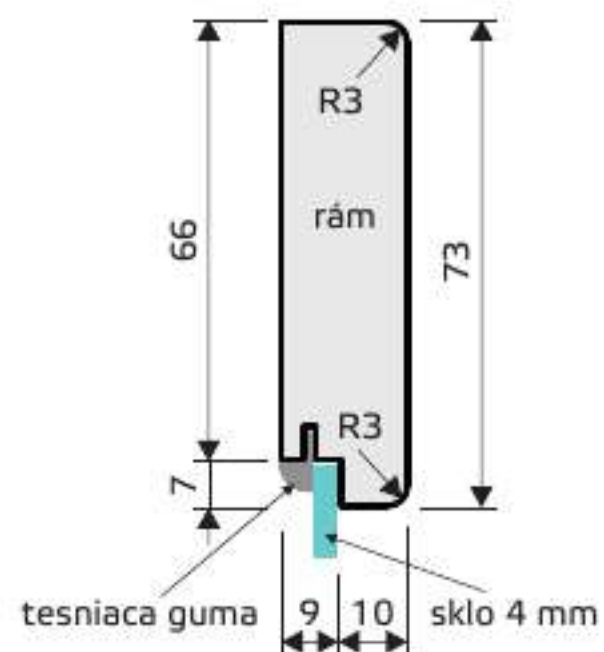
**6** cenová hladina

biela arctic
 vysoký lesk
 /BIAL/



vanilka
 vysoký lesk
 /AVL/



červená
 vysoký lesk
 /CERL/



marigold
 vysoký lesk
 /MARL/



tmavohnedá
 vysoký lesk
 /THNL/



grafit
 vysoký lesk
 /GRAL/



biela arctic
 /BIAA/



kašmír
 /KASM/



grafit
 /GRAF/



pino aurelio
 /PINO/



magnólia
 /MAGN/



dub san remo sand
 /DSAN/



dub bardolino
 /DBAR/



dub arlington
 /DARL/



dub wotan
 /DWOT/



sklo satinované
 /Z1/



sklo číre
 /Z5/



GALA

cenová hladina 4-5



GALA

materiál: LDTD + ABS hrana

hrúbka: 18 mm

zadná strana: v dekore prednej plochy

poznámka: úchytka je súčasťou prednej plochy, prevedenie nerez

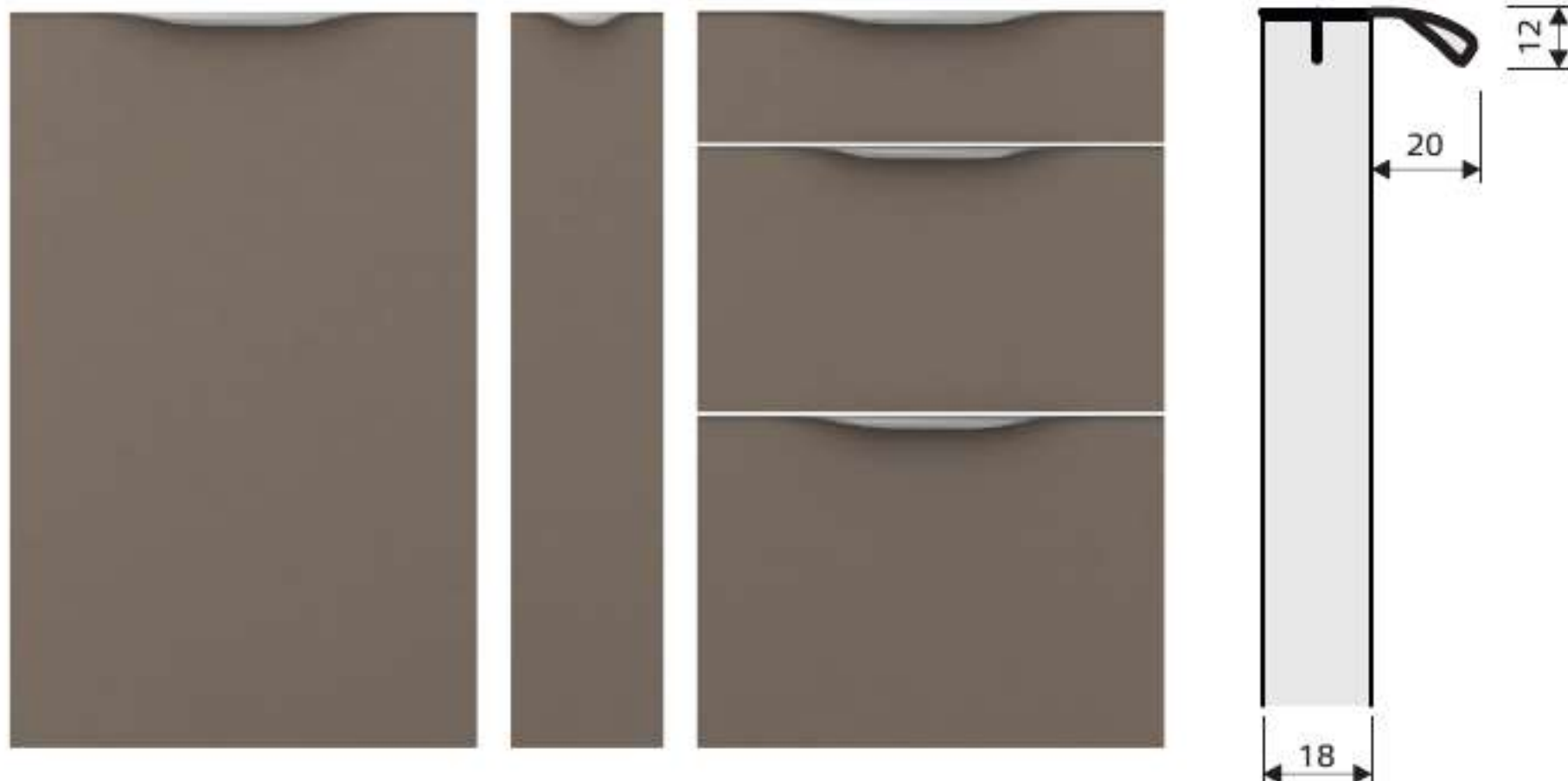

4 cenová hladina

kašmír
/KASM/



šedý kameň
/SEKA/



dub arlington
/DARL/



5 cenová hladina

biela vysoký lesk
/BIEL/



ivory vysoký lesk
/IVOL/



šedá vysoký lesk
/SEDL/



šedá diamant
/SEDD/



pino aurelio
/PINO/



IRIS

cenová hladina 4-6



IRIS

materiál: MDF polievaná + ABS hrana / LDTD + ABS hrana

hrúbka: 18 mm

zadná strana: v dekore prednej plochy



4 cenová hladina

dub san remo sand
/DSAN/dub wotan
/DWOT/dub riviera mountain
/DMON/dub halifax tabak
/DHAT/

6 cenová hladina

biela polievaná
vysoký lesk
/BIPL/vanilka polievaná
vysoký lesk
/VAPL/šedá polievaná perlička
vysoký lesk
/PESL/chilli polievaná
vysoký lesk
/CHPL/biela polievaná
supermat
/BPIS/kašmír polievaná
supermat
/KAPS/šedý kameň polievaná
supermat
/SKPS/šedá polievaná
supermat
/SEPS/čierna polievaná
supermat
/CIPM/bridlica čierna
/BRIC/dub kronberg svetlý
/DKRS/sklo satinované
/Z1/sklo číre
/Z5/

JELA

cenová hladina 6



JELA

materiál: MDF + fólia
hrúbka: 19 mm
zadná strana: vanilka

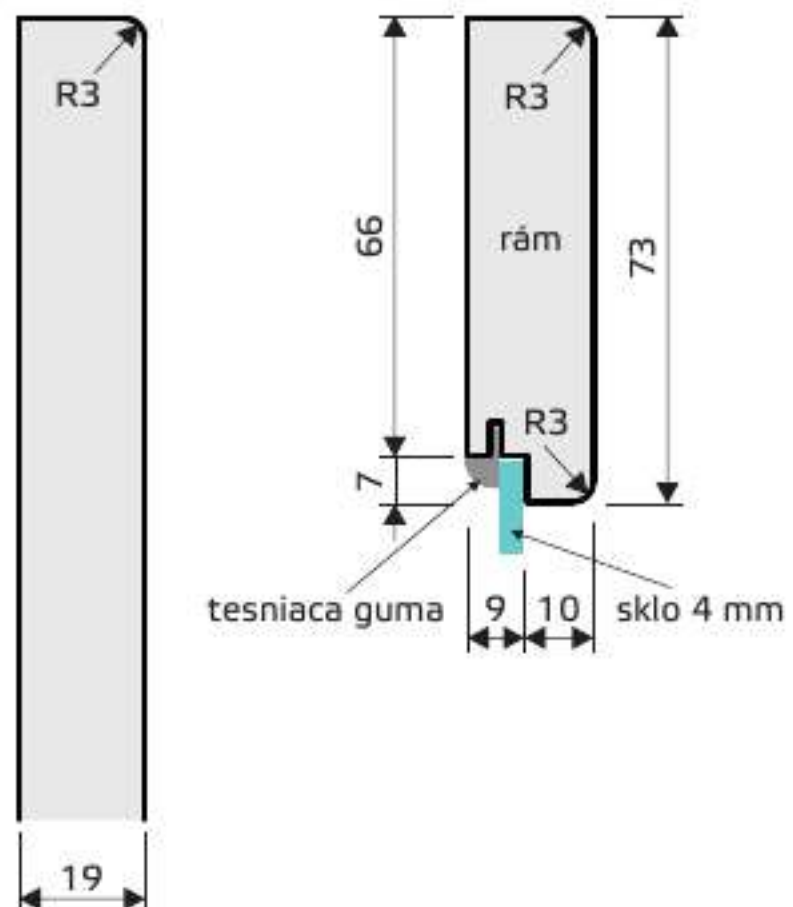

6 cenová hladina

kašmír
vysoký lesk
/KASL/



šedý kameň
vysoký lesk
/SKAL/



buk sand
/BKSD/



dub craft tabak
/DCRT/



sklo satinované
/Z1/



sklo čire
/Z5/



KATY

cenová hladina 6



KATY

materiál: MDF + fólia

hrúbka: 22 mm

zadná strana: vanilka

poznámka: frézovanie do plochy od šírky 263 mm a výšky 253 mm

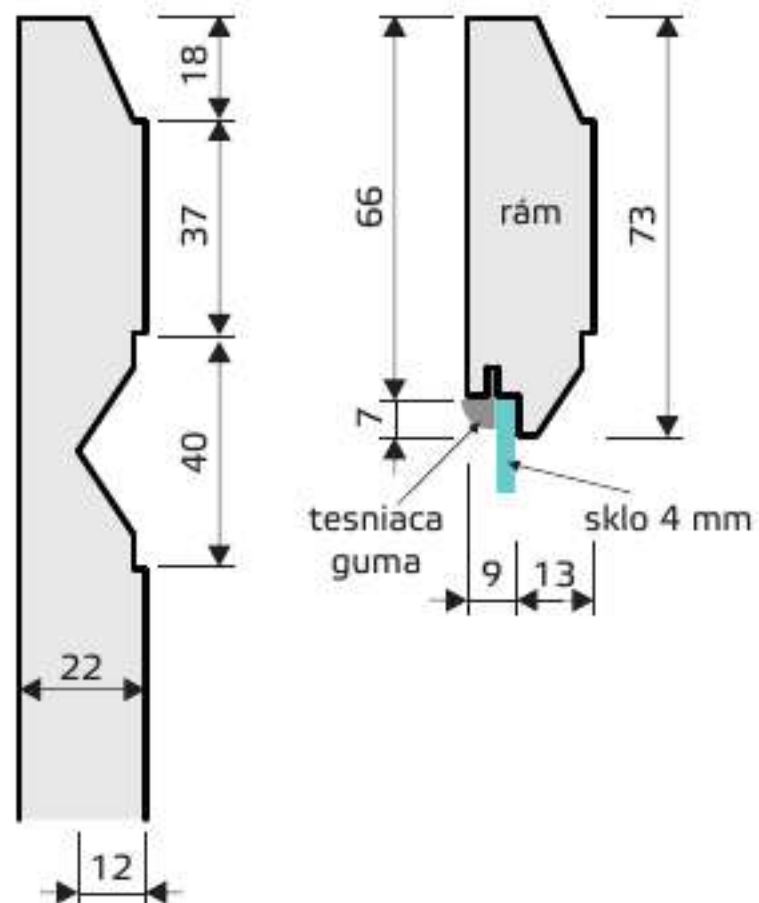
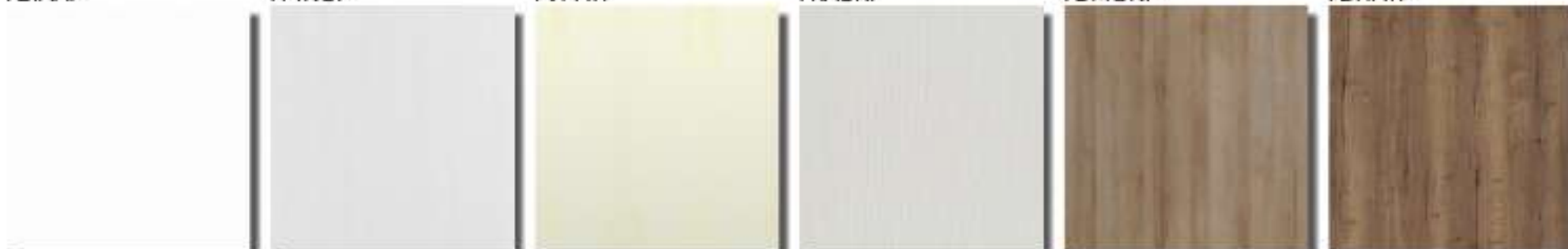
**6** cenová hladinabiela arctic
/BIAA/pino aurelio
/PINO/vanilka patina
/VPAT/kašmír raster
/KASR/dub riviera mountain
/DMON/dub halifax tabak
/DHAT/sklo satinované
/Z1/sklo flint
/Z3/sklo číre
/Z5/

ratan

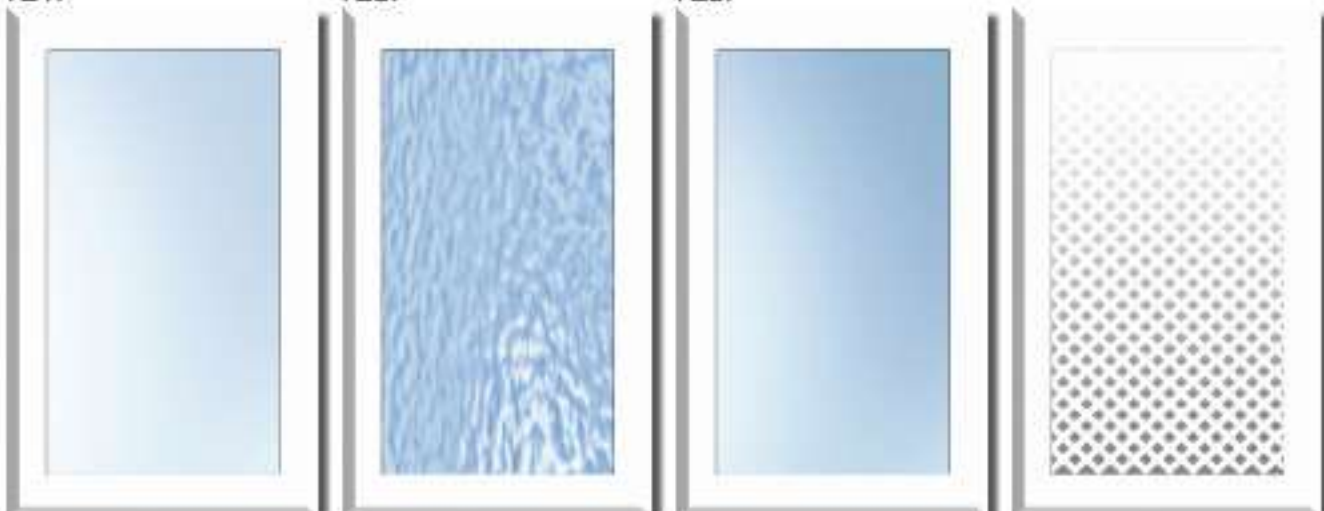
výplň ratan v ponuke
vo farbe:
biela arctic
vanilka patina
kašmír raster

LADA

cenová hladina 5



LADA

materiál: MDF + fólia

hrúbka: 19 mm

zadná strana: vanilka

poznámka: frézovanie do plochy od šírky 266 mm a výšky 253 mm

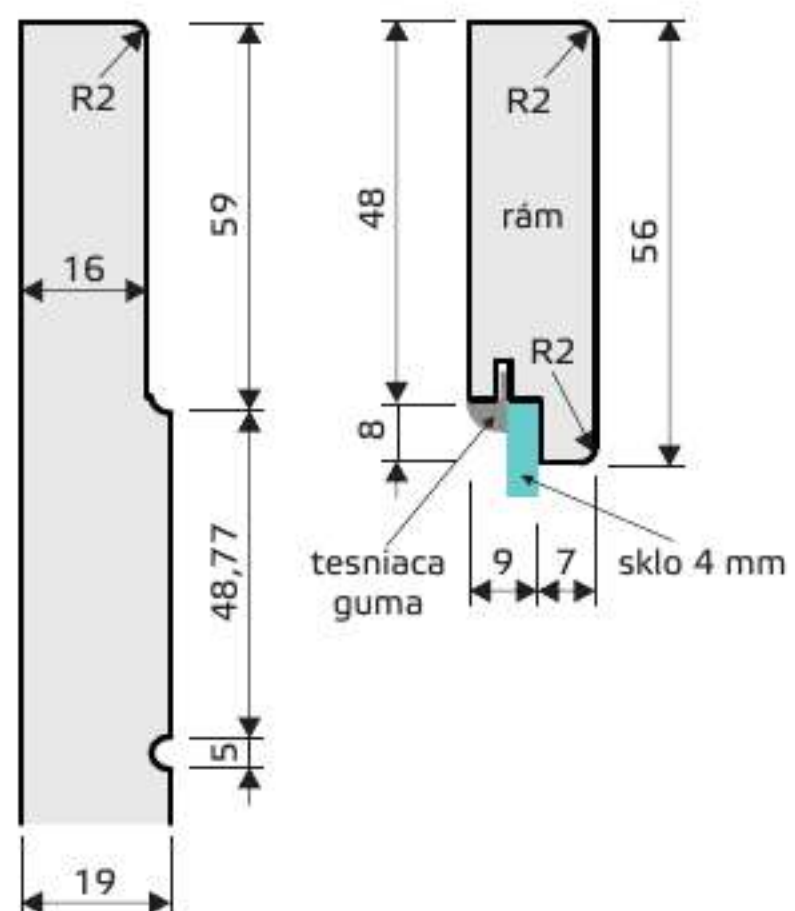
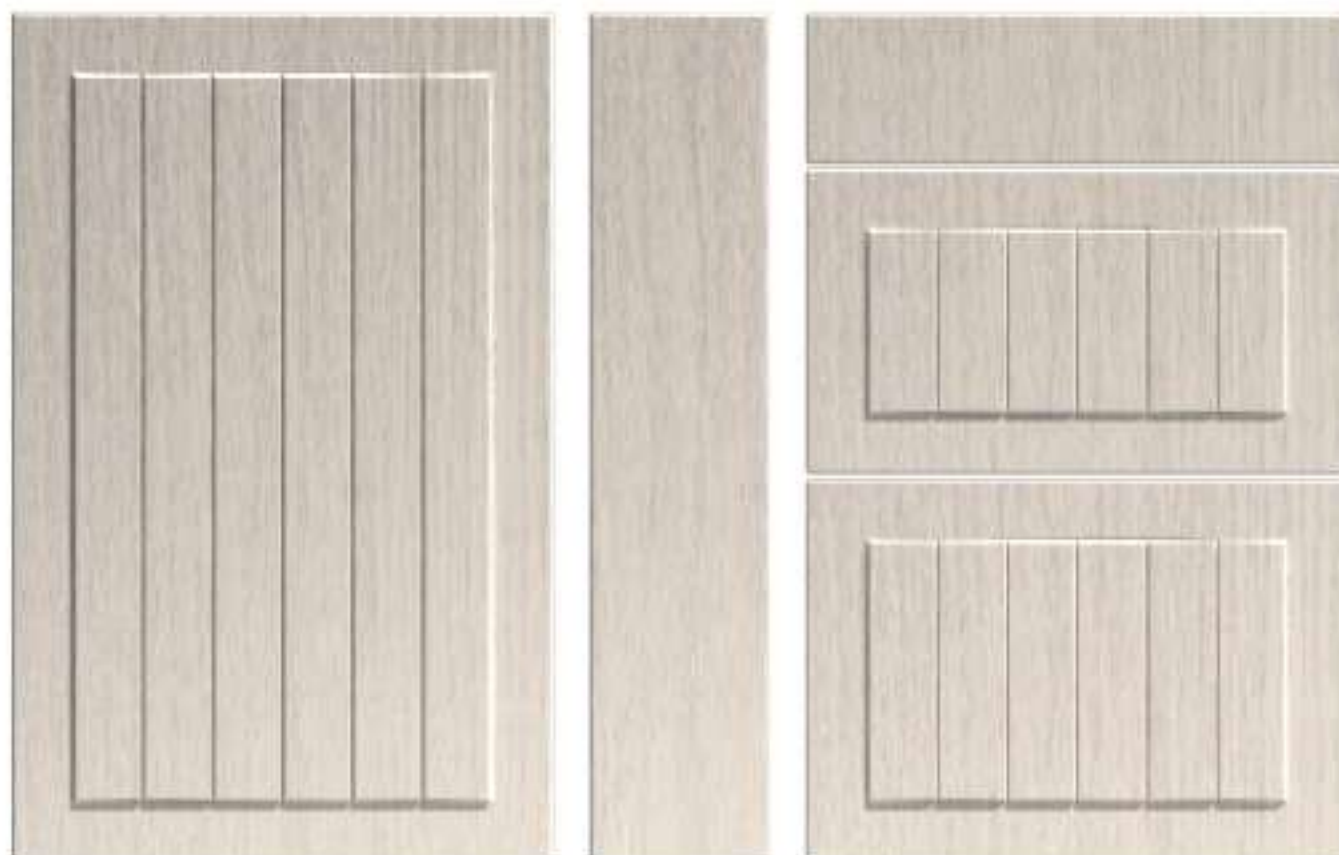
**5** cenová hladinabiela arctic
/BIAA/magnólia
/MAGN/cement
/CEME/kašmír raster
/KASR/sklo satinované
/Z1/sklo flint
/Z3/sklo číre
/Z5/

LEANDRA

cenová hladina 5



LEANDRA

materiál: MDF + fólia
 hrúbka: 22 mm
 zadná strana: vanilka

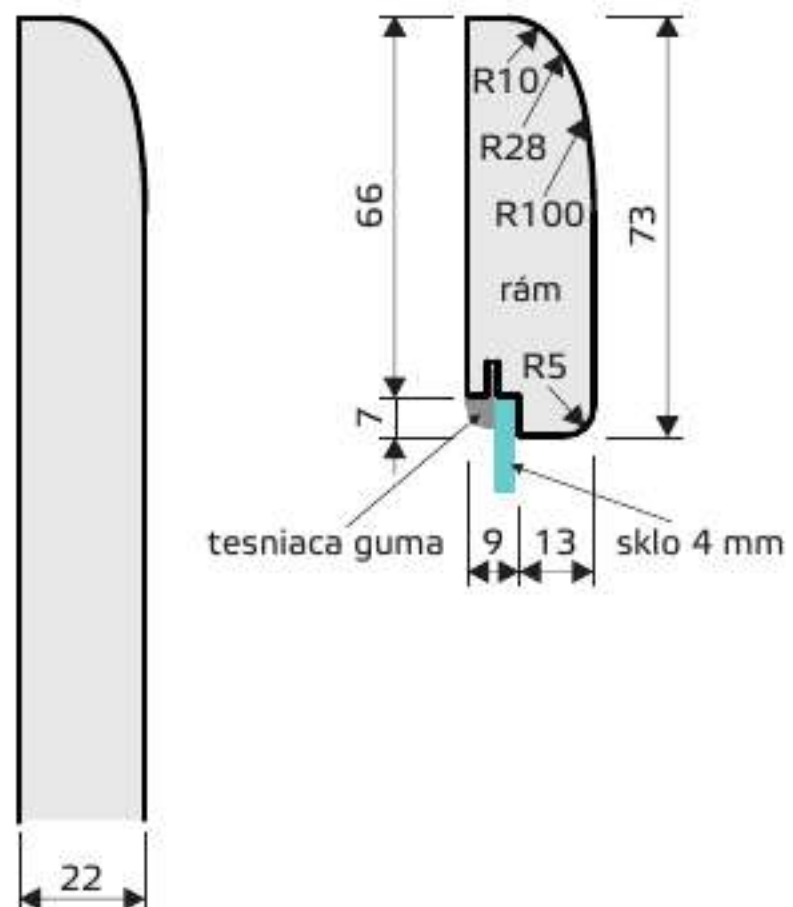

5 cenová hladina

vanilka
/VANI/



pino aurelio
/PINO/



dub san remo sand
/DSAN/



dub riviera mountain
/DMON/



sklo satinované
/Z1/



sklo čire
/Z5/



LOTA

cenová hladina 6



LOTA

materiál: MDF + fólia

hrúbka: 19 mm

zadná strana: vanilka

poznámka: frézovanie do plochy od šírky 266 mm a výšky 253 mm

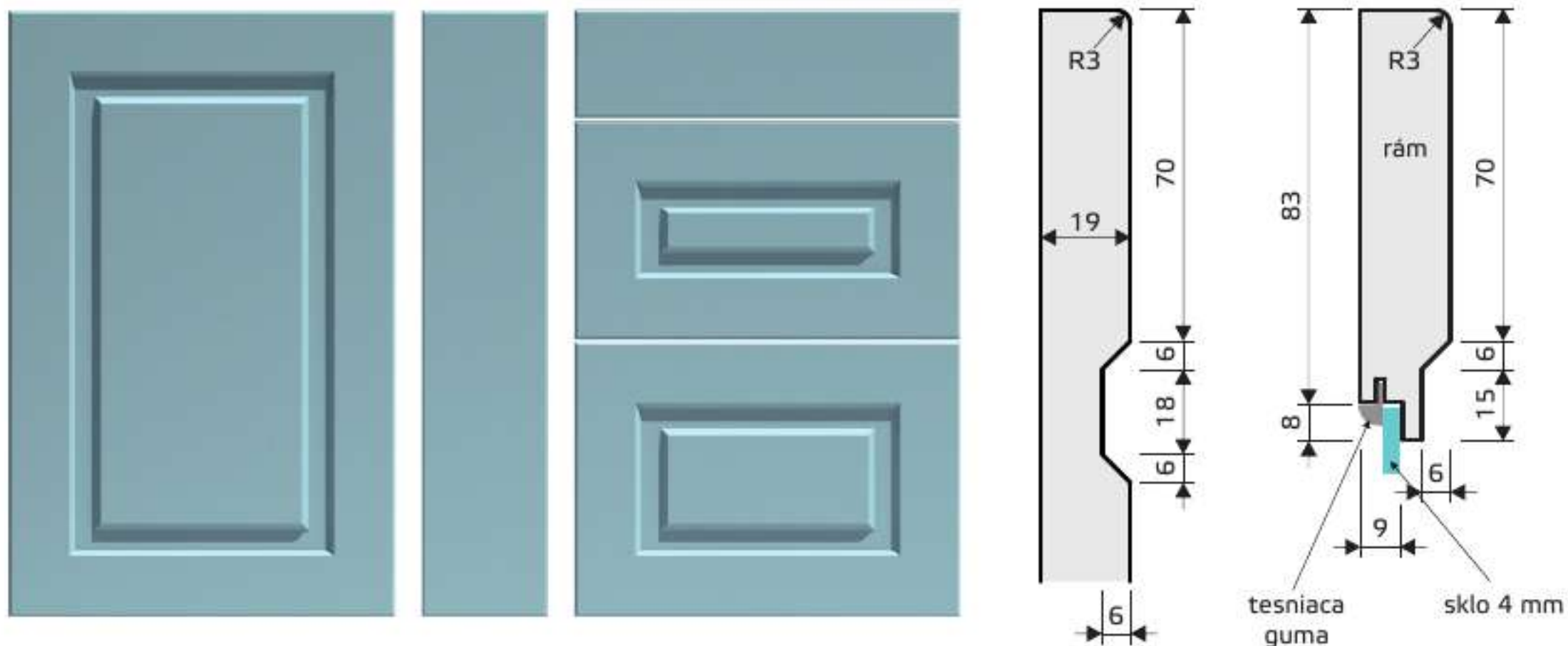
**6** cenová hladinabiela arctic
/BIAA/kašmír
/KASM/šedý kameň
/SEKA/fjord
/FJOR/cement
/CEME/sklo satinované
/Z1/sklo flint
/Z3/sklo číre
/Z5/

MANILA

cenová hladina 4



MANILA

materiál: MDF + fólia

hrúbka: 16 mm

zadná strana: vanilka

poznámka: frézovanie do plochy od šírky 269 mm a výšky 253 mm

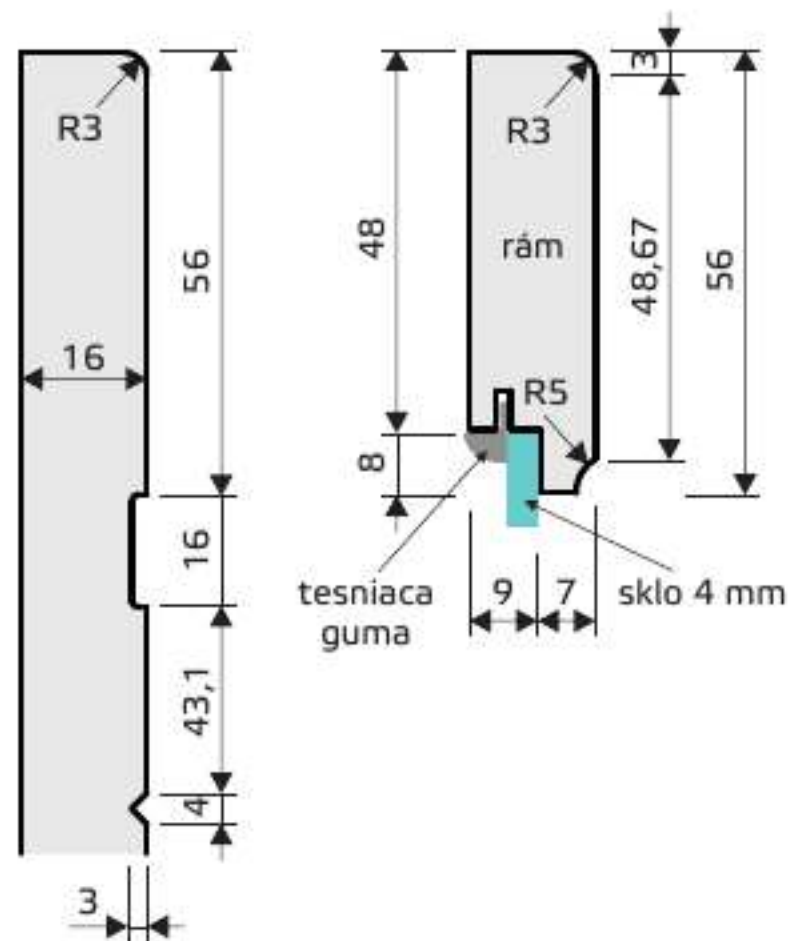
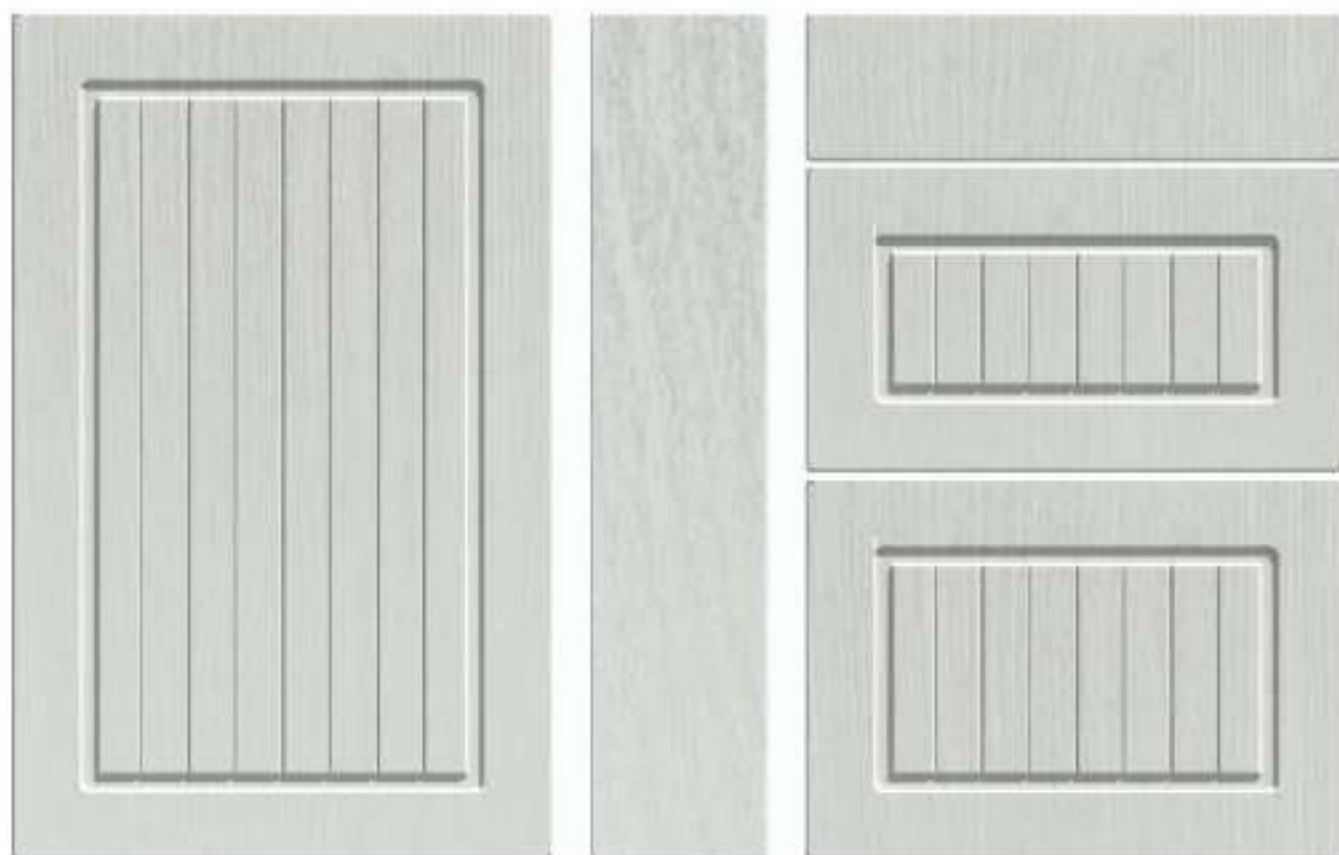
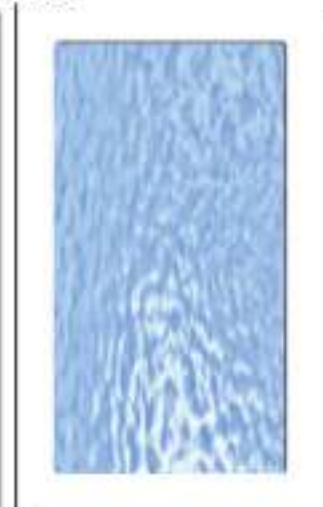
**4** cenová hladinavanilka patina
/VPAT/biela arctic
/BIAA/magnólia
/MAGN/plower mat
/PLOM/sklo satinované
/Z1/sklo flint
/Z3/sklo číre
/Z5/

PORTA

cenová hladina

6



PORTA

materiál: MDF + fólia

hrúbka: 19/16 mm

zadná strana: vanilka

poznámka: skladané od šírky 230 mm, bočné vlysy naložené, výplň s horizontálnou textúrou

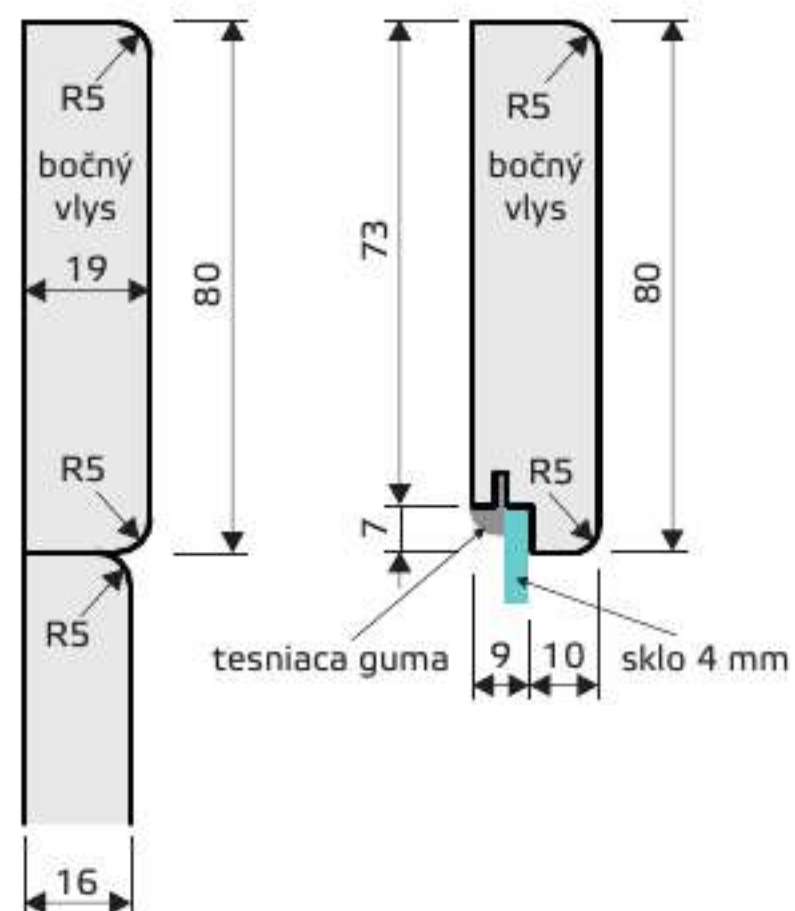
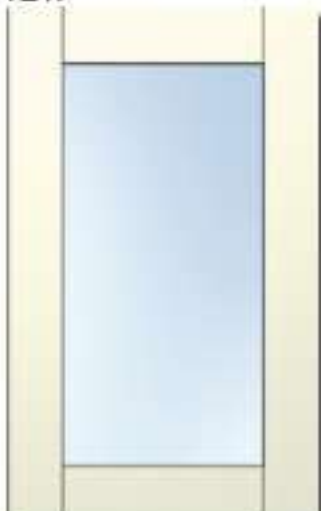
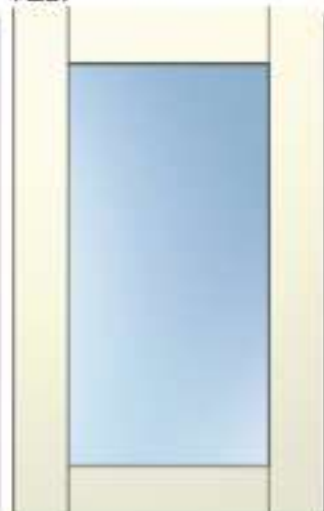
**6** cenová hladinavanilka
/VANI/pino aurelio
/PINO/vanilka patina
/VPAT/dub bardolino
/DBAR/sklo satinované
/Z1/sklo flint
/Z3/sklo číre
/Z5/

RADÚZA

cenová hladina 6



RADÚZA

materiál: DTD + dýha

hrúbka: 17/13 mm

zadná strana: vanilka

poznámka: rámová konštrukcia

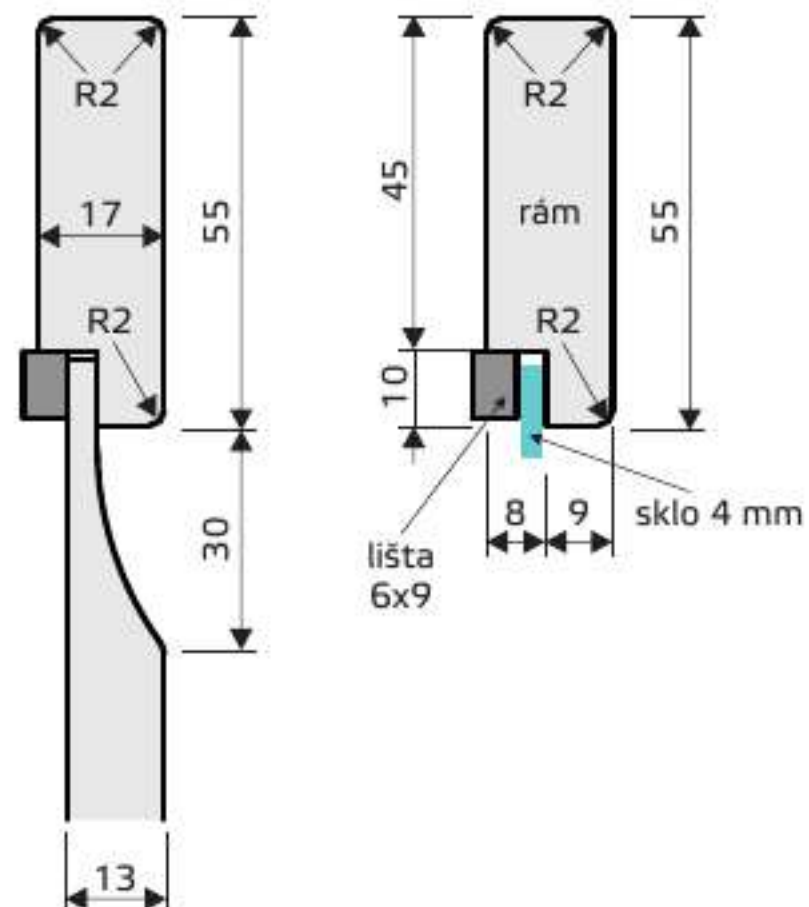
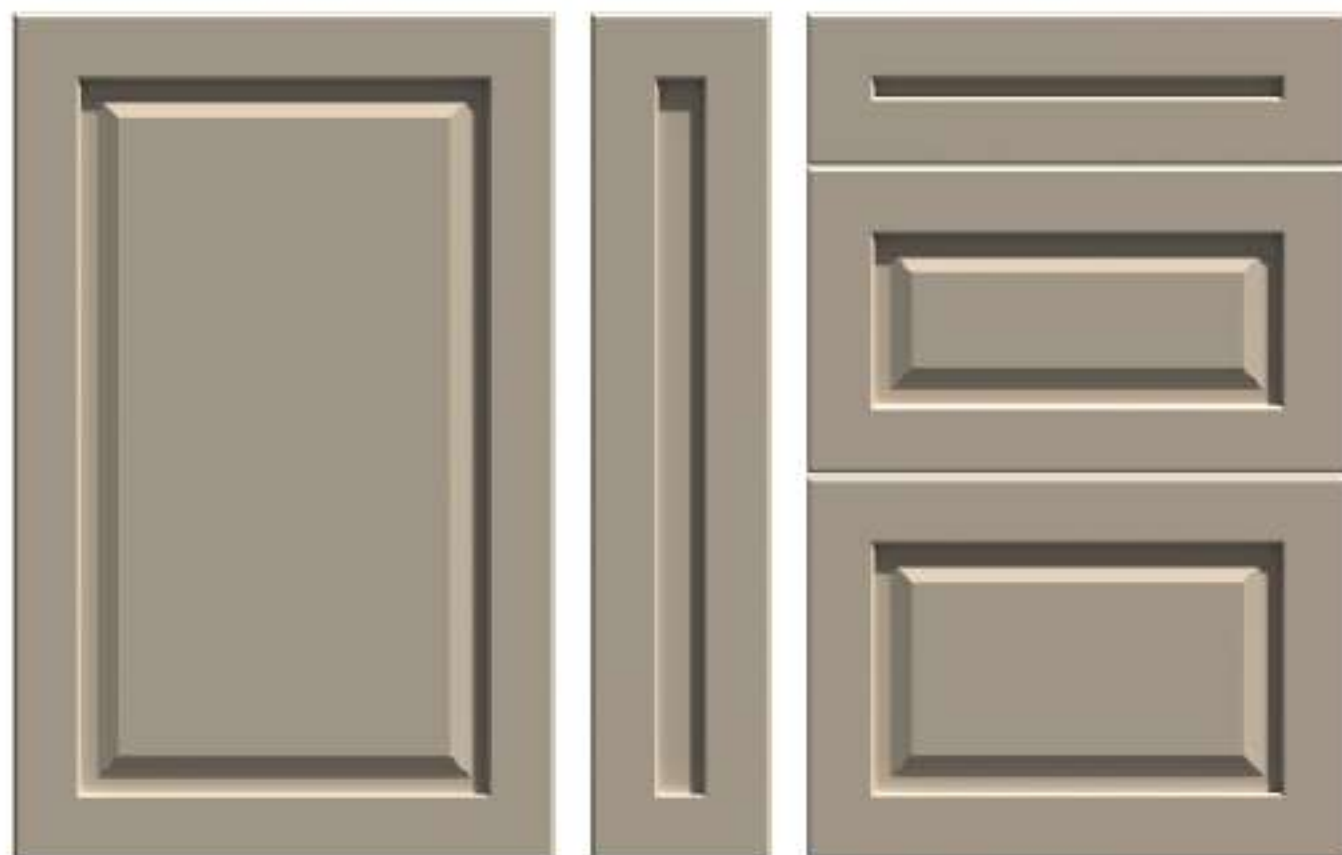
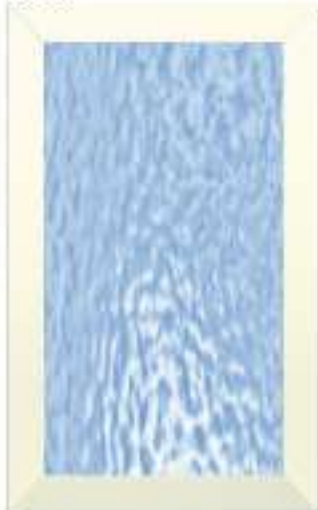
**6** cenová hladinadýha
vanilka
/VANI/dýha
kašmír
/KASM/sklo flint
/Z3/sklo čire
/Z5/

ratan

výplň ratan v ponuke
vo farbe:
vanilka
kašmír

SIMA

cenová hladina

6



SIMA

materiál: MDF + fólia

hrúbka: 19 mm

zadná strana: vanilka

poznámka: frézovanie do plochy od šírky 266 mm a výšky 253 mm

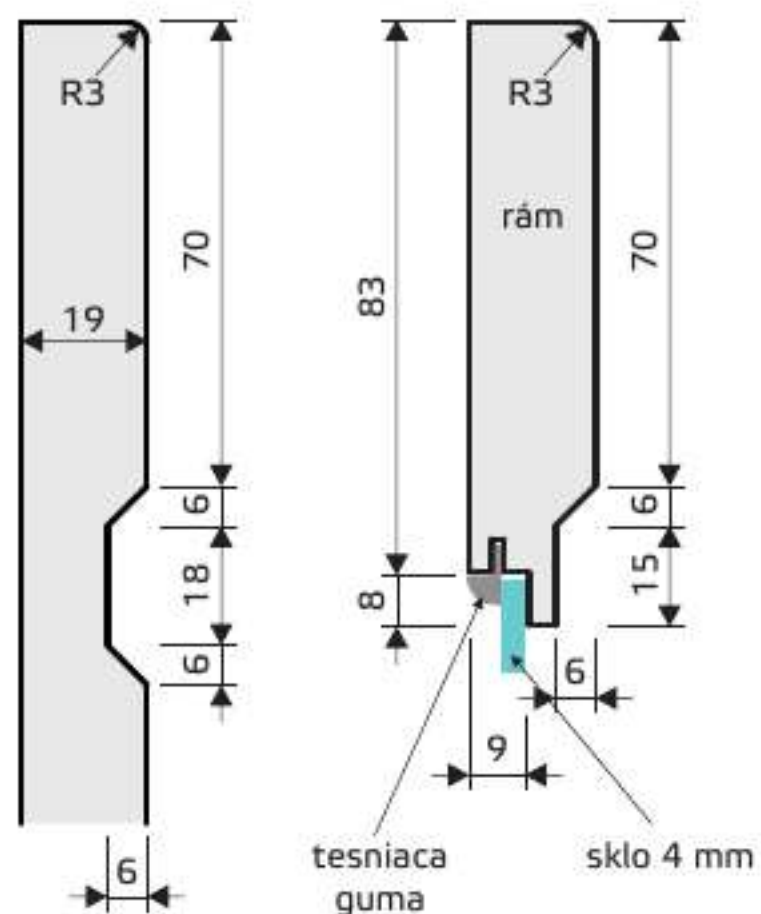
**6** cenová hladinamušľa
/MUŠE/plower mat
/PLOM/dub kronberg svetlý
/DKRS/sklo satinované
/Z1/sklo flint
/Z3/sklo číre
/Z5/

TEA

cenová hladina 6



TEA

materiál: MDF + fólia
 hrúbka: 19 mm
 zadná strana: vanilka

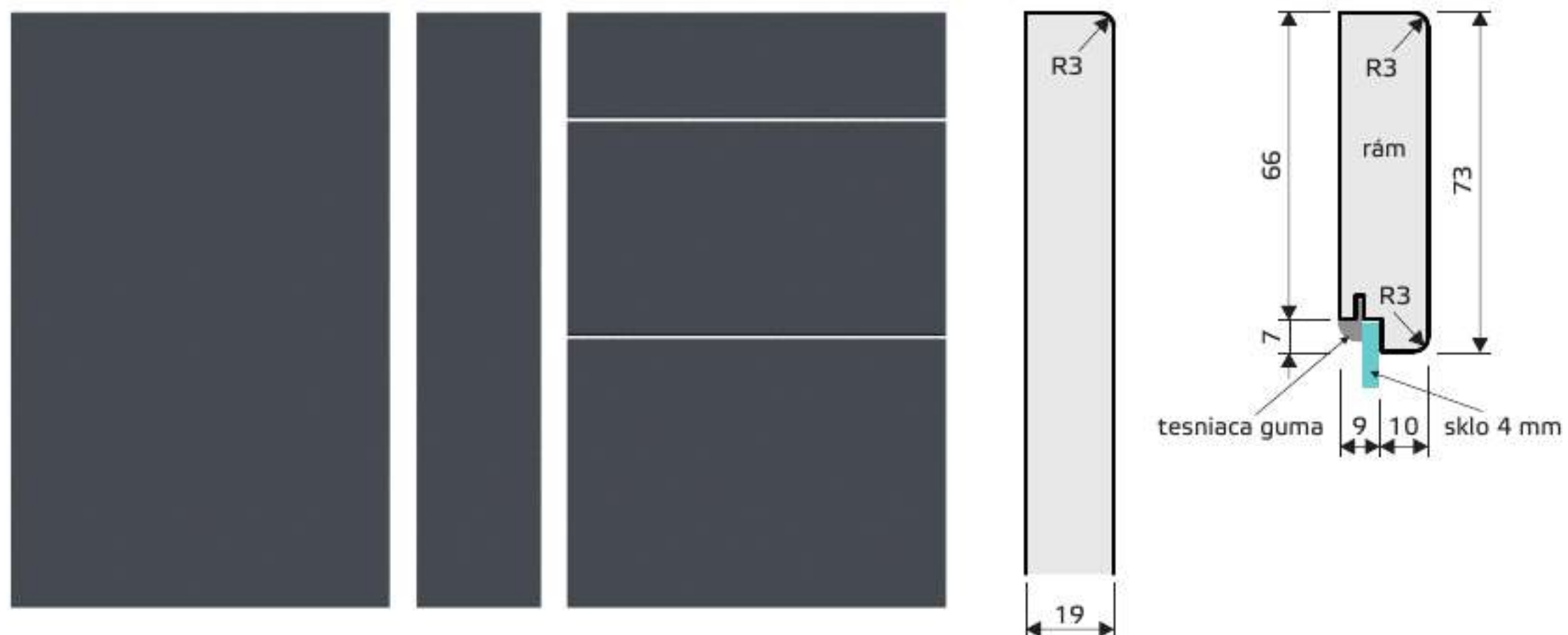
**6** cenová hladina

mušľa
 vysoký lesk
 /MUSL/



plower mat
 /PLOM/



cement
 /CEME/



dub kronberg svetly
 /DKRS/



dub halifax tabak
 /DHAT/



sklo satinované
 /Z1/



sklo čire
 /Z5/



TÍLIA

cenová hladina 5-7



TÍLIA

materiál: MDF polievaná + ABS hrana / LDTD + ABS hrana

hrúbka: 18 mm

zadná strana: v dekore prednej plochy

poznámka: úchytka je súčasťou prednej plochy, prevedenie nerez

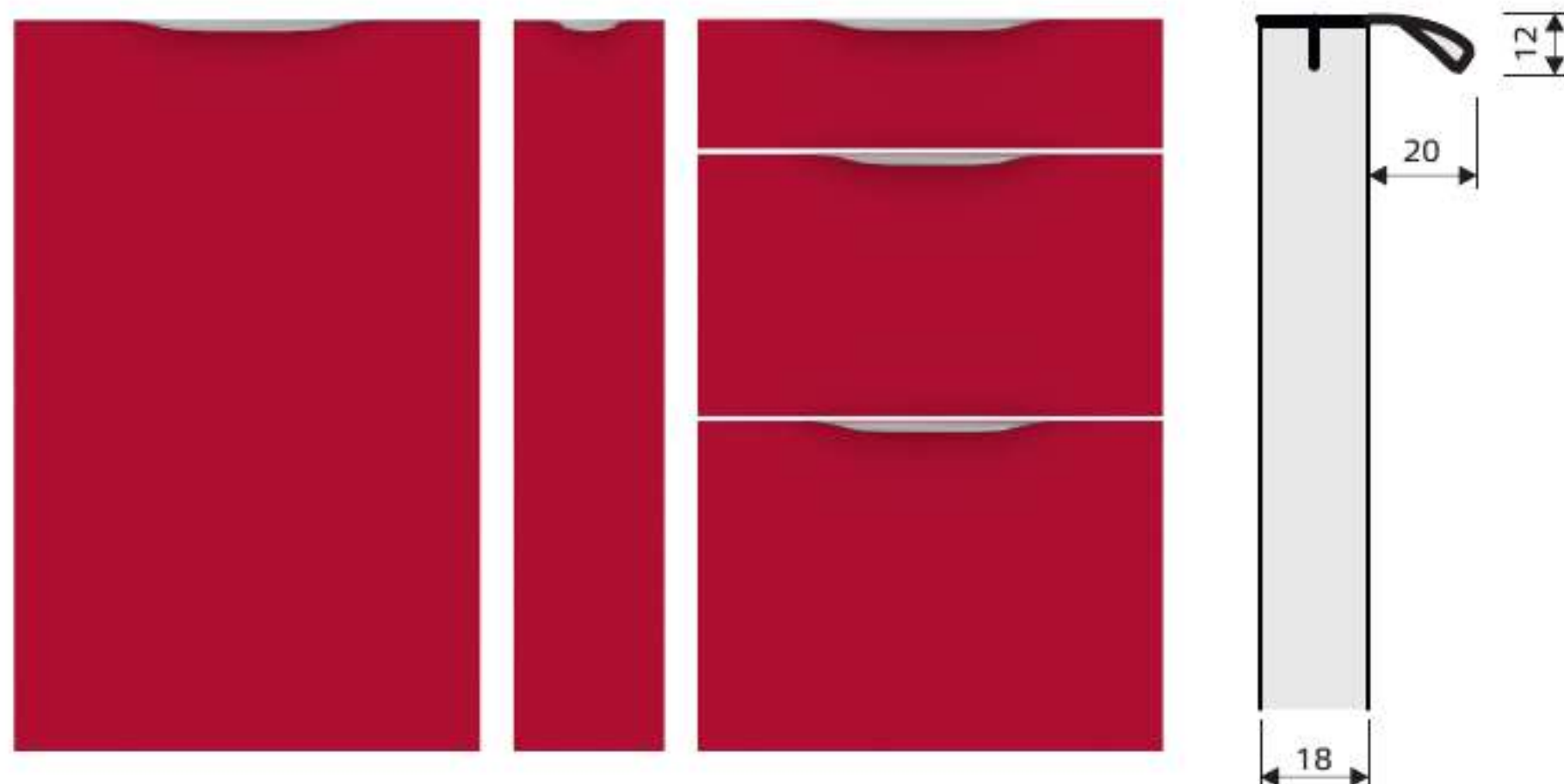

5 cenová hladina

dub san remo sand
/DSAN/



dub wotan
/DWOT/



dub riviera mountain
/DMON/



dub halifax tabak
/DHAT/



7 cenová hladina

biela polievaná
vysoký lesk
/BIPL/



vanilka polievaná
vysoký lesk
/VAPL/



šedá polievaná perlička
vysoký lesk
/PESL/



chilli polievaná
vysoký lesk
/CHPL/



biela polievaná
supermat.
/BIPS/



kašmír polievaná
supermat
/KAPS/



šedý kameň polievaná
supermat
/SKPS/



šedá polievaná
supermat
/SEPS/



čierna polievaná
supermat
/CIPM/

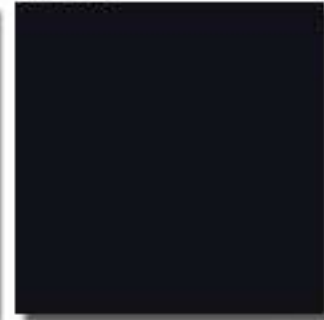

bridlica čierna
/BRIC/



dub kronberg svetlý
/DKRS/



TÍLIA 2

cenová hladina 5-7



TÍLIA 2

materiál: MDF polievaná + ABS hrana / LDTD + ABS hrana

hrúbka: 18 mm

zadná strana: v dekore prednej plochy

poznámka: úchytka je súčasťou prednej plochy, prevedenie titán

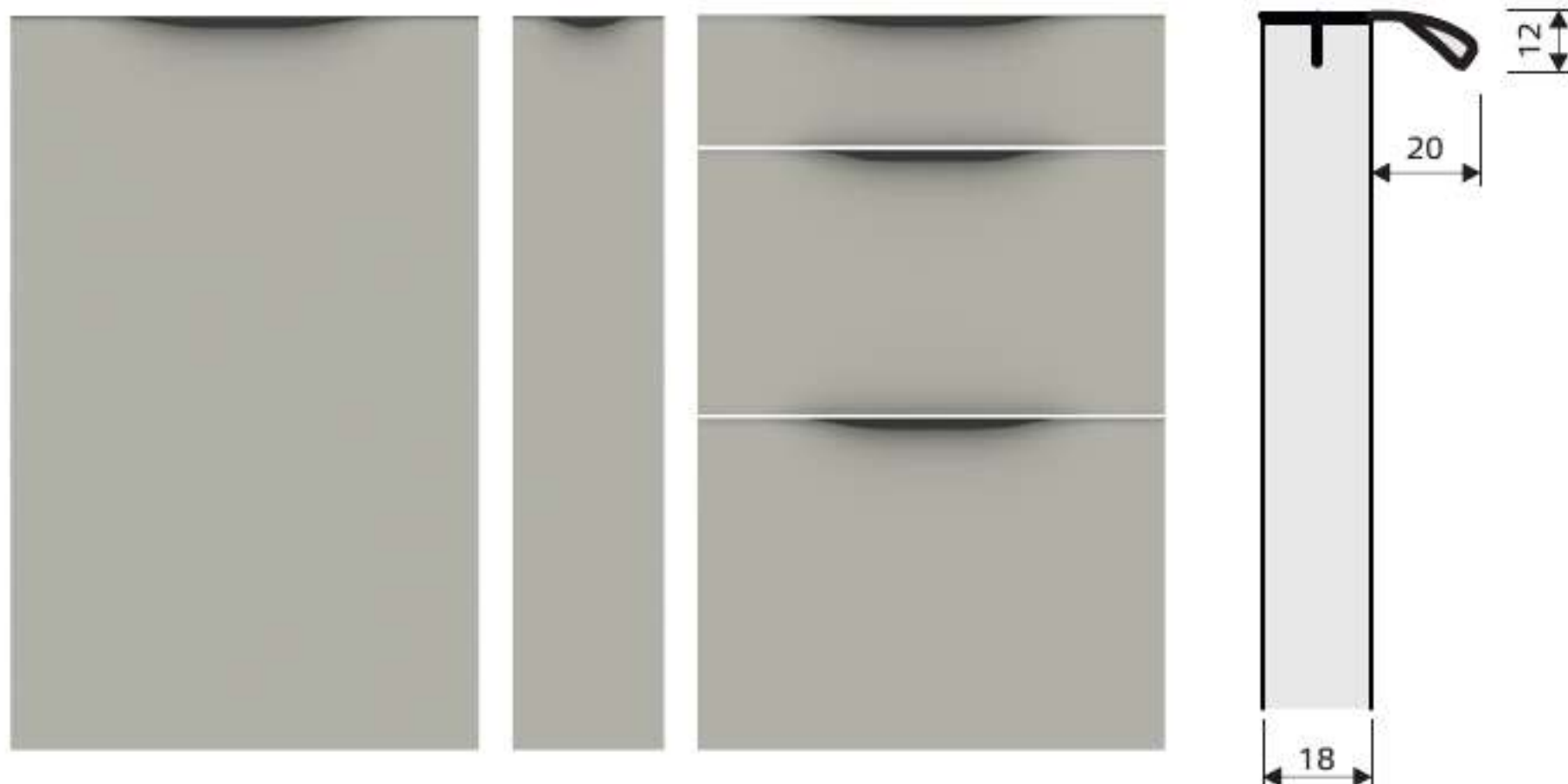

5 cenová hladina

dub san remo sand
/DSAN/



dub wotan
/DWOT/



dub riviera mountain
/DMON/



dub halifax tabak
/DHAT/



7 cenová hladina

biela polievaná
vysoký lesk
/BIPL/



vanilka polievaná
vysoký lesk
/VAPL/



šedá polievaná perlička
vysoký lesk
/PESL/



chilli polievaná
vysoký lesk
/CHPL/



biela polievaná
supermat
/BIPS/



kašmír polievaná
supermat
/KAPS/



šedý kameň polievaná
supermat
/SKPS/



šedá polievaná
supermat
/SEPS/



čierna polievaná
supermat
/CIPM/



bridlica čierna
/BRIC/



dub kronberg svetlý
/DKRS/



Hliníkové dvere

Typ AL1



samolepiaca úchytka TYP 451, šírka 160 mm, farebne zladená s rámom, materiál: hliník, súčasťou dverí sú závesy s tlmením



AL1- sklo satinované
/ALU-Z1/



Typ AL2



samolepiaca úchytka TYP 450, šírka 160 mm, farebne zladená s rámom, materiál: brúsený hliník, súčasťou dverí sú závesy s tlmením



AL2- sklo biela mat.
/SBIM/



AL2- bronzová mat.
/SBRM/



AL2- oranžová mat.
/SORM/

